

# aperta

EZTAG3 | PROXIMITY AND KEYPAD DOOR ENTRY



USER MANUAL



[www.espuk.com](http://www.espuk.com)

## System Components



Proximity and Keypad Reader



10 x Proximity Tags



1 x Hex Key  
4 x Plastic wall plug  
4 x Countersunk screws  
1 x Diode and 1 x Capacitor

## Optional Accessories



EVBPSBB  
Lock Power Supply



EV-EXIT  
Push to Release



EV-EBG  
Emergency Release



EV-ML-250/500XT  
Electro-magnetic Lock



ENTERD  
Electric Lock

## Contents

Installation .....	4
EZTAG3 Wiring Example 1 .....	5
EZTAG3 Wiring Example 2 .....	5

## Advanced Programming Guide

How to set-up Access Pin Number .....	6
How to set-up Access Tags .....	6
Deleting Access Pin or Tag .....	7
Changing Programming Pin .....	7
Clear all Pin and Tag Data .....	8
Default to Factory Settings .....	8
Lock 1 Output Operating Time .....	9
Enable 'Door Bell' Facility .....	9
Enable 'Tamper Alarm' facility .....	10
Access Pin Number for Lock 2 Output .....	10
Deleting Access Pin for Lock 2 .....	11
Lock Output Operating Time for Lock 2 Output .....	11
System setup record .....	12
User Guide .....	14
Technical Specification .....	14

## Installation



↑  
Release hex screw from the bottom of the keypad

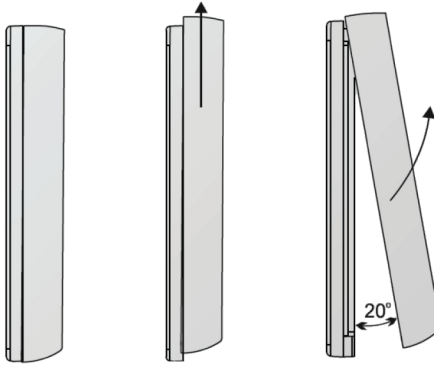

(Side View)  
Push the keypad up to release from mount plate

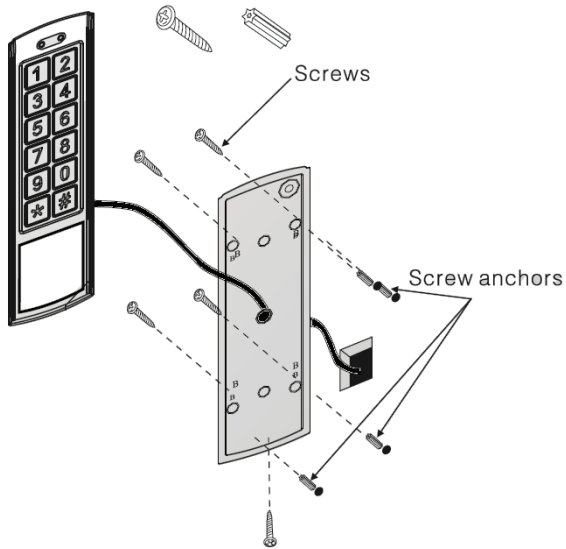

Thread system cable through the cable entry hole then make the system connections (as per the wiring diagram), mount the bracket to the surface and slide the keypad to the mountplate, re-fit the hex screw to secure into position.

Note: if using more than one keypad, ensure that the keypads are mounted a minimum 185cm apart



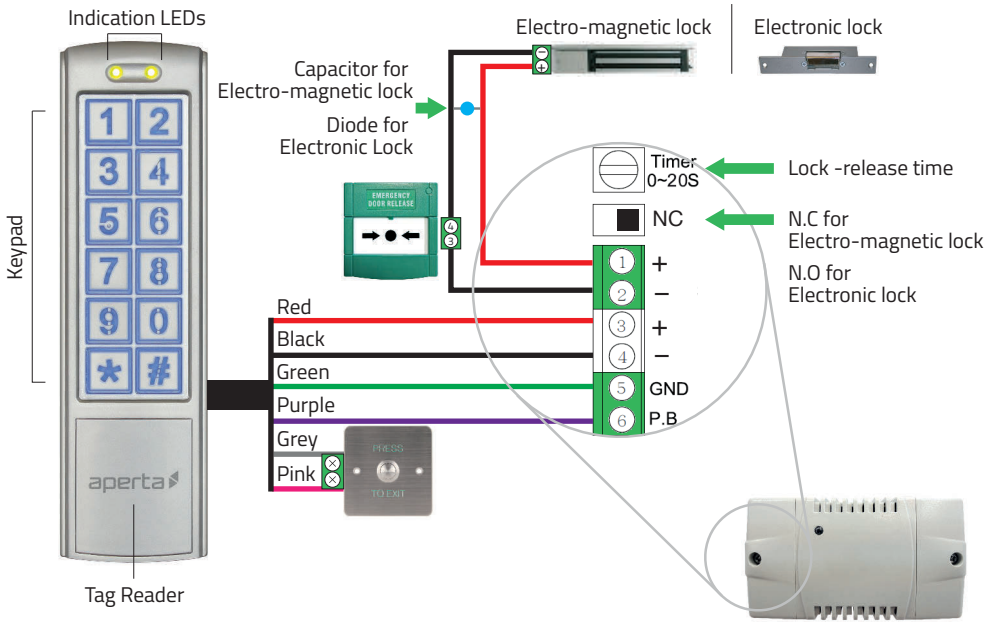



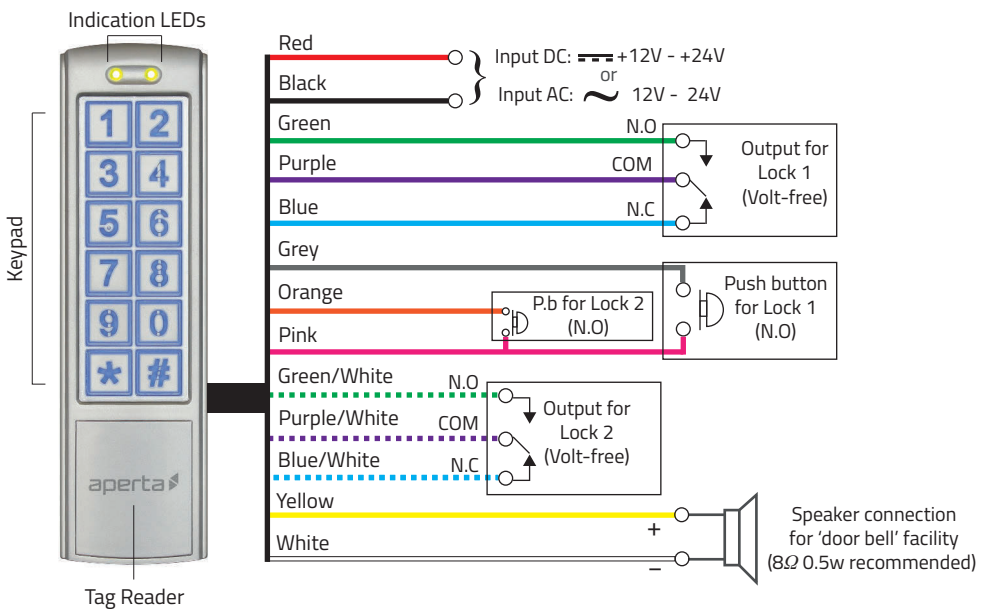



## EZTAG3 Wiring Example 1

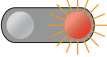











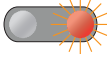

## EZTAG3 Wiring Example 2



## How to set-up Access Pin Number







Step Number	Action	Keypad Indication
1	Enter Programming  (Default)	 Long Tone
2		
3		 Long Tone
4	Enter a starting location number 	 Double Tone
5	 Enter a 4 digit pin (1234 not be used)	 Long Tone
6	 To end programming	

## How to set-up Access Tags

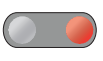

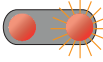

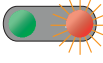

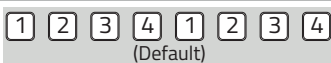

Step Number	Action	Keypad Indication
1	Enter Programming  (Default)	 Long Tone
2		
3		 Long Tone
4	Enter a unused location number* 	 Long Tone
5	 Enter number of tags to be registered	 Tone
6	 Present the tag with the lowest serial number	 Tone
7	All other batch tags will auto register  To end programming	

\*Each tag will use up a location number

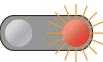
## Deleting Access Pin or Tag

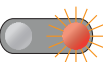

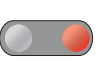



Step Number	Action	Keypad Indication
1	Enter Programming  (Default)	 Long Tone
2	Enter the location number of tag/pin 	
3	 To delete	
4	 To end programming	

## Changing Programming Pin



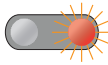



Step Number	Action	Keypad Indication
1	Enter Programming  (Default)	 Long Tone
2		
3	 Enter new 4 digit programming pin	
4	 Re-enter new 4 digit programming pin	 Long Tone
5	 To end programming	

Note; To access keypad's programming mode, the 4 digit programming code is entered in twice

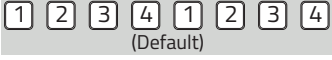
## Clear all Pin and Tag Data

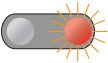





Step Number	Action	Keypad Indication
1	Enter Programming  (Default)	 Long Tone
2		
3		 Long Tone
4	 To end programming	

## Default to Factory Settings



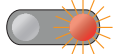
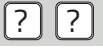





Step Number	Action	Keypad Indication
1	Enter Programming  (Default)	 Long Tone
2		
3		 Long Tone
4	 To end programming	

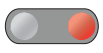

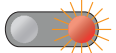
## Lock 1 Output Operating Time









Step Number	Action	Keypad Indication
1	Enter Programming  (Default)	 Long Tone
2		
3	Enter number of seconds 00-99 	 Long Tone
4	 To end programming	

## Enable 'Door Bell' Facility

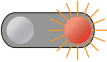
Step Number	Action	Keypad Indication
1	Enter Programming  (Default)	 Long Tone
2		
3	 To enable  To disable	 Long Tone
4	 To end programming	









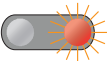

 Becomes the 'door bell' push in normal mode

## Enable 'Tamper Alarm' facility









Step Number	Action	Keypad Indication
1	Enter Programming  (Default)	 Long Tone
2		
3	 To enable  To disable	 Long Tone
4	 To end programming	

Tamper alarm activates the keypad's internal buzzer and 'door bell' output if the light sensor is exposed

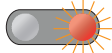

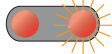

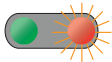

## Access Pin Number for Lock 2 Output

Step Number	Action	Keypad Indication
1	Enter Programming  (Default)	 Long Tone
2		
3		 Long Tone
4	Enter an unused location number 	 Double Tone
5	 Enter a 4 digit pin (1234 should not be used)	 Long Tone
6	 To end programming	

## Deleting Access Pin for Lock 2

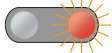
Step Number	Action	Keypad Indication
1	Enter Programming  (Default)	 Long Tone
2		
3	Enter the location number of pin 	
4	 To delete	
5	 To end programming	

## Lock Output Operating Time for Lock 2 Output

Step Number	Action	Keypad Indication
1	Enter Programming  (Default)	 Long Tone
2		
3	Enter number of seconds 00-99 	 Long Tone
4	 To end programming	





## User Guide

To release Lock 1

(A)  
Enter a programmed  
Access Pin number



(B)  
Present a  
registered tag



To access programming mode

1 2 3 4 1 2 3 4  
(Default)

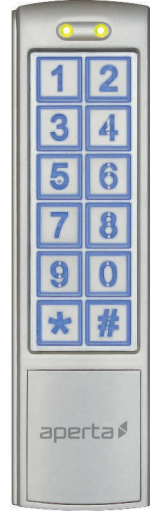

## Technical Specification

DC input	12 - 24volts
AC input	12 - 24volts
Standby current	80ma
Operating current (without lock)	110ma

Working temperature	-20c to +50c
Reader frequency	125KHz
IP rating	65
Dimension	150 x 44 x 24mm



**Elite Security Products**  
Unit 7, Target Park, Shawbank Rd  
Lakeside, Redditch B98 8YN



Telephone: 01527 51 51 50  
Fax: 01527 51 51 43  
email: [info@espuk.com](mailto:info@espuk.com)

E&OE - Errors and omissions excepted. L15

[www.espuk.com](http://www.espuk.com)